



ICE
PROTECTIONS
& CONTRÔLE
COMMANDE

**USER'S GUIDE
NPIH800 AND NPIH800R
EARTH OVERCURRENT
RELAY**

**NPIHD800 AND NPIHD800R
EARTH OVERCURRENT RELAY
WITH OR WITHOUT DIRECTIONAL
CRITERIA**

ICE - 11, rue Marcel Sembat - 94146 ALFORTVILLE CEDEX - France
TEL.: (33) 01 41 79 76 00 - FAX: (33) 01 41 79 76 01 – E-MAIL: contact@icelec.com
WEB SITE: www.groupeice.com

User's Guide NPIH800 – NPIHD800 NPIH800R -NPIHD800R	Issue : e	File: A336E Print : 04/05/2011	Date : 01/2011
--	------------------	---	-----------------------

This document is the sole property of ICE. No duplication nor release to third party is allowed without prior authorization

FOREWORD

The aim of this handbook is to provide to the User information useful for the operation of NPIH800 - NPIHD800 and NPIH800R – NPIHD800R relays with the local MMI.

We advise you to read it carefully, in order to take note of the available functionalities and to proceed to connection and power of the product in accordance with the provided recommendations.

Locally, setting, commissioning and real time or event readings are accessible from keyboard and displayed on the protection display.

To be fully exploited, the available functions must be parameterized and consulted with the setting software PC – Protection, provided with the product.

Before any use, we recommend you to read the safety instructions of this User's guide.

Info: this guide is the substitute of A0336E1E. (NPIH800-NPIHD800 USER'S GUIDE)

This document is the sole property of ICE. No duplication nor release to third party is allowed without prior authorization

User's Guide NPIH800 – NPIHD800 NPIH800R – NPIHD800R	Date : 01/2011	Folio : 1
	Print : 04/05/2011	Indice : e

CONTENTS

1. Safety instructions	4
1.1 Documentation	4
1.2 Connection of the relays NPIH800 – NPIH800R – NPIHD800 – NPIHD800R	4
1.3 On load withdrawal	5
1.4 Removal and destruction	5
2. Protection and operation functions	6
2.1 Protection functions NPIH800 - NPIHD800 and NPIH800R - NPIHD800R	6
2.2 Operation functions NPIH800 - NPIHD800 and NPIH800R - NPIHD800R	6
2.3 Protection and operation functions additional to NPIHD800 - NPIHD800R	6
2.4 Locally available User's functions	7
2.5 Remotely available User's functions	7
3. First use	8
3.1 Default screen	8
3.2 Presence of a fault or an alarm	8
3.3 Acknowledgment of latching output relays – ANSI 86	8
4. General information on menus	9
4.1 Setting mode (In / Out)	9
4.2 Access code	11
4.3 Assignment of output units	12
5. Menu list	13
5.1 Access to main menus	13
5.2 Measurement menu (only V1.24 and V2.xx firmware)	15
5.3 Maintenance menu (since firmware V3.00)	16
5.4 Overcurrent menu	17
5.5 Directional menu (only NPIHD800 and NPIHD800R)	19
5.6 Generic functions menu	20
5.7 Closing function menu	21
5.8 Logical selectivity menu	22
5.9 Telecontrol menu	23
5.9.1 Telecontrol menu (V1.24 and V2.xx Firmware)	23
5.9.2 Telecontrol menu (since V3.00 Firmware)	25
5.10 Disturbance recording menu	26
5.11 Counters menu	27
5.12 Operation menu	28
5.12.1 Operation menu (Firmware V1.24 and V2.XX)	28
5.12.2 Operation menu (since V3)	30
5.13 Modbus® Communication menu (optional)	33
5.14 Change of code menu	33
5.15 Information menu	34
5.15.1 Information menu (V1.24 and V2.xx firmware)	34
5.15.2 Information menu (since V3.00)	35
6. Content of an event	36
6.1 Events generated on 51N/50N thresholds	36
6.2 Customized inputs events	37
6.3 Other events	37
6.4 Acknowledgement of events	38
6.5 Reading of the last 250 memorized events	38
7. List of faults or operation messages	39

This document is the sole property of ICE. No duplication nor release to third party is allowed without prior authorization

User's Guide NPIH800 – NPIHD800 NPIH800R – NPIHD800R	Date : 01/2011 Print : 04/05/2011	Folio : 2 Indice : e
--	--------------------------------------	-------------------------

7.1	List of faults or operation messages (Firmware V1.24 and V2.xx).....	39
7.2	List of faults or operation messages (since firmware V3.00)	40
8.	Connection of NPIH800 and NPIHD800 protections	41
8.1	Rear view of NPIH800 and NPIHD800 with location of the terminal blocks (with short-circuiting devices)	41
8.2	Rear view of NPIH800 and NPIHD800 with location of the terminal blocks (without short-circuiting devices)	42
8.3	NPIH800 and NPIHD800 connections	43
8.4	NPIH800 and NPIHD800 diagrams.....	43
9.	Connection of NPIH800R and NPIHD800R relays	44
9.1	Rear view of NPIH800R with location of the terminal blocks	44
9.2	Rear view of NPIHD800R with location of the terminal blocks.....	45
9.3	NPIH800R – NPIHD800R Fixing rods	46
9.4	NPIH800R connections	47
9.5	NPIHD800R connections.....	47
9.6	NPIH800R and NPIHD800R wire section	48
9.7	NPIH800R and NPIHD800R diagrams.....	48
10.	Connection of the Modbus RS485 communication	49
10.1	Characteristics of the network cable	49
10.2	Resistance of adaptation of the RS 485 connection	50
10.3	Polarization of the RS 485 connection	51
10.4	RS 485 connection not used	51

1. Safety instructions

For your safety, we recommend you to read the following information carefully. They have the aim of specifying the precautions essential to the good installation and the correct operation of the relays.

1.1 Documentation

Following documentations are available for the NP800 and NP800R:

- ◆ Application guide of the NP800 and NP800R series
- ◆ User's Guide of the Setting Software
- ◆ User's Guide (for each kind of relay)
- ◆ First Handling Guide (for each kind of relay)
- ◆ Diagram of each relay
- ◆ Dimensions and mounting diagram
- ◆ Matrix choice and dimensions of ring core type C.T.
- ◆ User's Guide and diagram of the BA800

We advise you to read them before any handling.

1.2 Connection of the relays NPIH800 – NPIH800R – NPIHD800 – NPIHD800R

The terminal blocks of the relays are studied to ensure the safety of the people during the operation of the relays.

During installation, commissioning or maintenance, they can however present high voltages and possibly a thermal heating. Consequently, the following precautions must be respected:

- ◆ Connection of the terminal blocks at installation must be carried out after having ensured of the absence of any voltage
- ◆ Their access during operation must be carried out through adequate means ensuring as well electric as thermal insulation
- ◆ The connection of the earth at the back of the relays must imperatively be done with mean of a 2.5 mm² wire.

Before powering the relays, it will be necessary to check in particular:

- ◆ The value of the voltage rating of the auxiliary supply and its polarization
- ◆ The tightening of the:
 - fixing rods of the current terminal blocks (NPIH800 - NPIHD800)
 - fixing rods of the relay case (NPIH800R - NPIHD800R)
- ◆ The good realization of connections
- ◆ The integrity of the connection to the earth.

1.3 On load withdrawal

With voltage or on load, it is formally misadvised to withdraw the:

- connectors and the current terminal blocks*
- relay (NPIH800R - NPIHD800R)

* For NPIH800-NPIHD800 relays fitted with short-circuiting devices

1.4 Removal and destruction

The relays should in no case be opened by the User. During their removal, they must be completely isolated from any external polarity and condensers must be discharged by connecting their external terminals to the earth.

Destruction of the relays will have to be carried out in accordance with legislation in force, in particular in compliance with the environment and safety requirements.

2. Protection and operation functions

2.1 Protection functions NPIH800 - NPIHD800 and NPIH800R - NPIHD800R

- ◆ Earth fault overcurrent protection, with one ANSI 51N and one ANSI 50N thresholds
- ◆ Logic selectivity function on the earth-fault thresholds
- ◆ Cooling start/ Closing function to avoid spurious trips when closing the circuit breaker
- ◆ ANSI 50NBF, circuit breaker failure function by checking of the disappearance of the earth-fault current. (Configuration available only by the setting software)
- ◆ ANSI 86, latching output contacts (Configuration available only by the setting software)
- ◆ ANSI 74TC, trip circuit supervision (Configuration only by the setting software)

- ◆ Monitoring of closings and trips

2.2 Operation functions NPIH800 - NPIHD800 and NPIH800R - NPIHD800R

- ◆ Two setting groups
- ◆ Assignment of digital inputs
- ◆ Assignment of relay outputs
- ◆ User programmable LEDs
- ◆ Monitoring of trips and reclosings
- ◆ Help in circuit breakers maintenance: number of operations with alarm threshold
- ◆ Storage of the last 250 events
- ◆ Storage of four 52 periods of 4 disturbance recordings, according to COMTRADE standard
- ◆ 4 or 8 User configurable generic functions.

2.3 Protection and operation functions additional to NPIHD800 - NPIHD800R

- ◆ ANSI 67N earth-fault directional function, applicable to ANSI 50N and ANSI 51N protections
- ◆ Network frequency Measure
- ◆ Residual Voltage Measure

2.4 Locally available User's functions

Locally, the following functions are available:

- ◆ Choice of language
- ◆ Setting in or out of order of the functions
- ◆ Customized identification of protection
- ◆ Setting of adjustment and primary values for the two tables
- ◆ Assignment of the inputs / outputs
- ◆ Reading of fault values
- ◆ Reading of each memorized value: measurements and counters
- ◆ Reset of counters
- ◆ Reading of events
- ◆ Configuration of disturbance recording and local trigger
- ◆ Configuration of Modbus® communication.

2.5 Remotely available User's functions

The following functionalities can be accessed through the RS232 or RS485 links:

- ◆ Saving of configuration
- ◆ Commissioning tests: LCD display, adjustment of contrast, LEDs
- ◆ Commissioning tests: relays, wiring
- ◆ Reading of real time values: measurement and counters
- ◆ Reading of disturbance recordings.
- ◆ ANSI 50N_BF circuit breaker failure function
- ◆ ANSI 86, latching output contacts
- ◆ ANSI 74TC, trip circuit supervision

These functions are however available with the setting software through the RS232.

3. First use

When powering the relay, the displays below can appear. The recommended action allows starting the parameter setting of protection.

3.1 Default screen

In absence of a fault, the protection displays the zero sequence overcurrent measurement in HV value:

```
CURRENT I0  
0.0 A
```

3.2 Presence of a fault or an alarm

If a fault or alarm occurs, a message indicates the type of fault.

```
TRIP EARTH LOW  
THRESHOLD >
```

Note: According to the type of fault, the message of the second line changes. This message disappears at once after acknowledgement of the fault and is replaced by the following message.

```
TRIP I0 > E  
10/12 16:38.15 R
```

This message remains until the acknowledgement of the fault by the User.

3.3 Acknowledgment of latching output relays – ANSI 86

For the Firmware s \geq V2.20 and $<$ V3.00, see the « Counters » menu.

For the Firmware s $>$ V3.00, see the « Maintenance » menu.

4. General information on menus

All parameters can be accessed for reading. On the other hand, parameters are write-protected by an access code requested on the first modification.

4.1 Setting mode (In / Out)

Press any key except CLEAR to enter in setting mode.

If no parameter has been modified, exit the mode by pressing the CLEAR key:

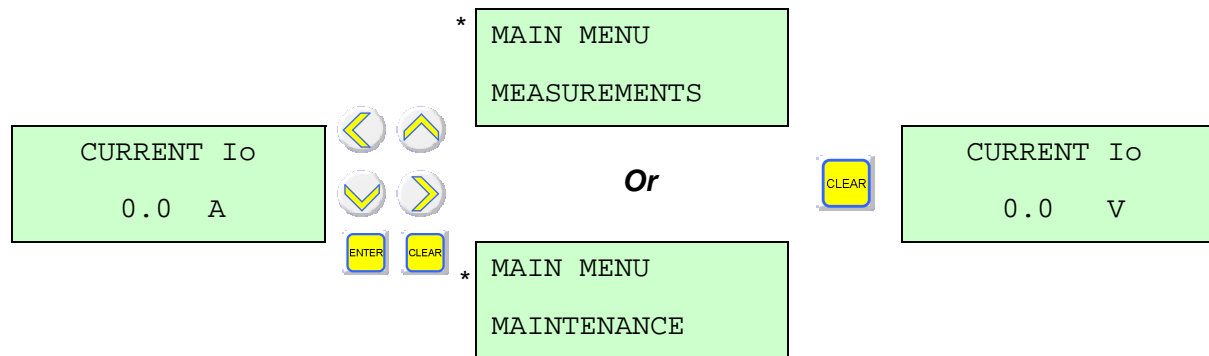

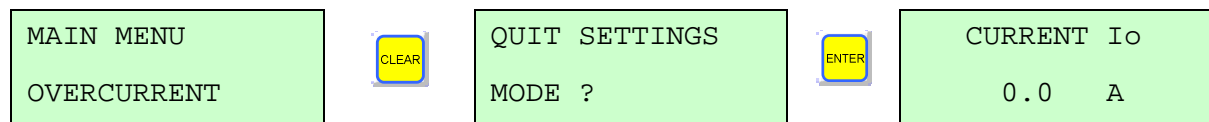

* « Measurements Menu » for the V1.24 and V2.xx Firmware and, « Maintenance Menu » from the V3.00 Firmware.

If a parameter has been modified, confirm the exit from setting mode:



Without any operation, return to default screen is carried out automatically after 5 minutes.

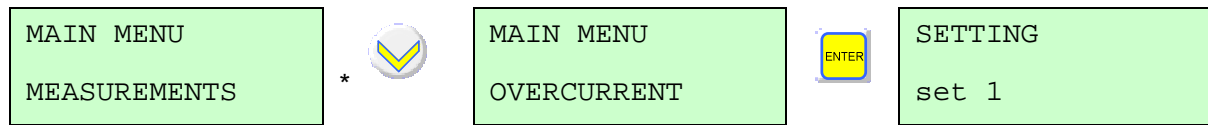

Modification of a parameter

Use the  and  keys to select a menu, then press the ENTER key to access the first parameter.

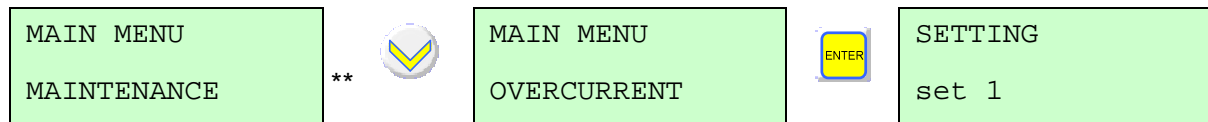

Or



Use the  and  keys to access the various parameters in the menu:

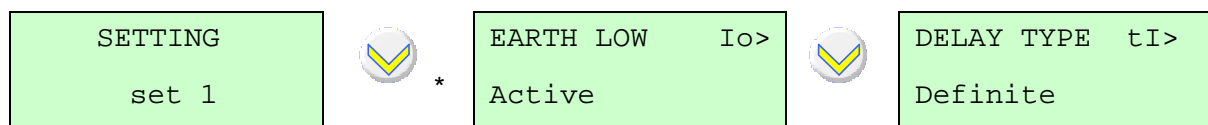

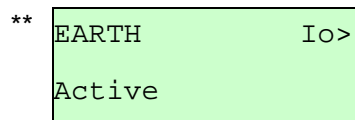

Or



* V1.24 and V2.xx Firmware

** since the V3.00 Firmware.

Use the  and  keys to modify the parameter.

You must confirm your change using the ENTER key after each parameter modification. After storing the new parameter value, next parameter is displayed:

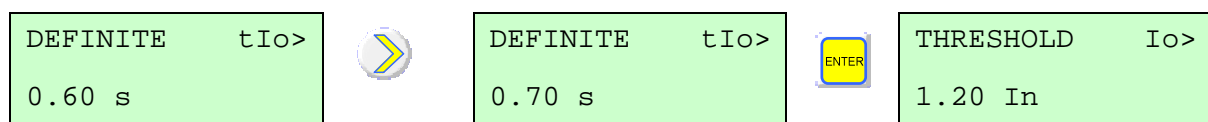

Use the CLEAR and  keys to change menu:

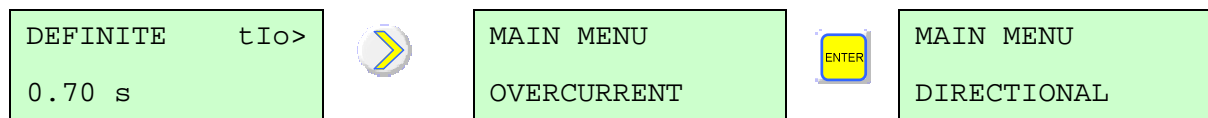

Leaving any sub menu with the CLEAR key will lead to the above menu.

4.2 Access code

On first modification of a parameter, the software requests the access code.

The factory-programmed code is " ICE1 ".

To enter your own customised code, use the " CHANGE CODE " menu. The code can be composed up to four alphanumeric characters.

The following example shows how to replace code "AA" with " 99 ":

MAIN MENU CHANGE CODE		Press on « ENTER » to confirm
OLD PASSWORD —		Press on ► until obtaining the letter « A »
OLD PASSWORD I		Press on ▼ to displace the cursor « _ »
OLD PASSWORD I_		Press on ► until obtaining the letter « A »
OLD PASSWORD AA		Press on « ENTER » to confirm
NEW PASSWORD —		Press on ◀ until obtaining the letter « 9 »
NEW PASSWORD 9		Press on ▼ to displace the cursor « _ »
NEW PASSWORD 9_		Press on ◀ until obtaining the letter « 9 »
NEW PASSWORD 99		Press on « ENTER » to confirm
MAIN MENU CHANGE CODE		

In case of loss of the code, contact us to obtain an emergency password for your configuration.

4.3 Assignment of output units

Relays assigned to a function are displayed with « * ».

The key  allows displacing the cursor « _ » on the relay(s) to assign.

The key  allows assigning or not the relays used by the functions.

Example: assignment of relay B to trip function tIo>. At the beginning, no function was assigned to this relay.

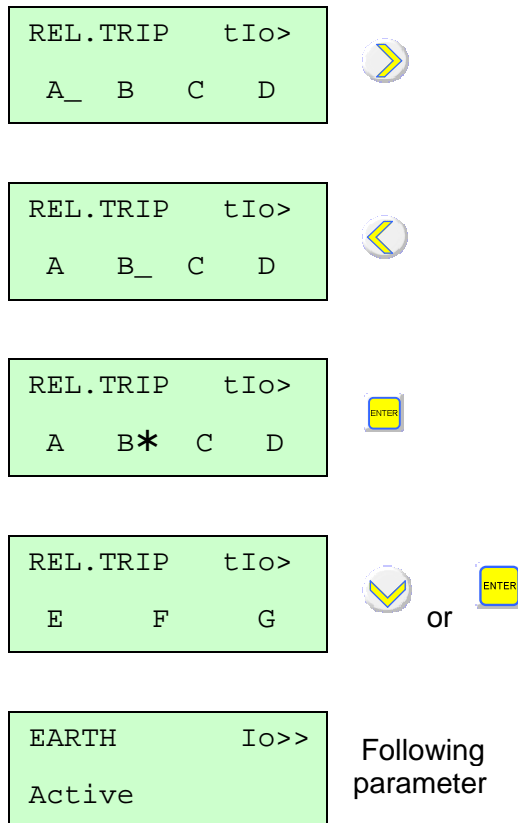









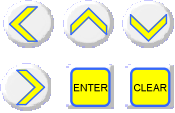



Caution: do not forget to confirm by ENTER key.

5. Menu list

5.1 Access to main menus

The following menus enable setting of the available functions. Each one allows access to the parameters of adjustment and ensures their coherence.







<p>CURRENT I_o 0.0 A</p> 	<p>Press on any key other than CLEAR to enter the parameter setting mode</p>	<p>Press on CLEAR key to leave the parameter setting mode</p>
<p>MAIN MENU MEASUREMENTS</p>	<p>Real time measures (V1.24 and V2.xx firmware)</p>	<p>See chapter 4 to select a menu</p>
<p><i>or</i></p>		
<p>MAIN MENU MAINTENANCE</p>	<p>Real time measures (since V3.00 Firmware)</p>	
<p>MAIN MENU OVERCURRENT</p> 	<p>Parameters of the functions: 50N, 51N</p>	
<p>MAIN MENU DIRECTIONAL</p> 	<p>Parameters of the directional function 67N</p>	<p>NPIHD800 and NPIHD800R</p>
<p>MAIN MENU GENERIC FUNCTION</p> 	<p>Parameters of the customized functions</p>	
<p>MAIN MENU CLOSING FUNCTION</p> 	<p>Parameters of the closing function (reclosing)</p>	
<p>MAIN MENU LOG. SELECTIVITY</p> 	<p>Parameters of the logical selectivity option</p>	<p>(if option available)</p>
<p>MAIN MENU TELECONTROL</p> 	<p>Parameters of the remote control option</p>	<p>(if option available)</p>
<p>MAIN MENU PERTURBOGRAPHY</p> 	<p>Information about disturbance recording</p>	

MAIN MENU COUNTERS	Information about counters	
		
MAIN MENU OPERATION	Operating parameters to be defined at commissioning	
		
MAIN MENU RS485 COMMS	Configuration of the Modbus RS485 communication option	NPIH800-NPIHD800 (if option available)
		
MAIN MENU CHANGE CODE	Change of the access code	
		
MAIN MENU INFORMATION	Information about protection	
		
MAIN MENU EVENTS	Reading of the event log	

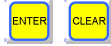







Leaving any sub menu with the CLEAR key will lead to the above menu.

5.2 Measurement menu (only V1.24 and V2.xx firmware)

This menu displays any real time measurement of the protection, as well as the values kept in memory.

MAIN MENU MEASUREMENTS 	Available real time measures	
CURRENT I _o 0.00 A 	Measure of the earth fault primary current	0.0 to 65535 A
FREQUENCY 50.00 Hz 	Measure of the network frequency	45 to 55 if Fn = 50 Hz 55 to 65 if Fn = 60 Hz
VOLTAGE V _r 0 V 	Measure of the residual primary voltage	0 to 655 350V (NPID800 - NPIHD800R)
AVER. CURRENT I ₀ 0.0 A 	Value of the average earth-fault primary current	0 to 65535A
SETTING set 1 	Display of the active setting group	Set 1 or Set 2
02/07/03 10:19:42	Day / Month / Year Hour / minute / second	

5.3 Maintenance menu (since firmware V3.00)











MAIN MENU MAINTENANCE 	Available real time measures	
CURRENT I _o 0.00 A 	Measure of the earth fault primary current	0.0 to 65535 A
FREQUENCY 50.00 Hz 	Measure of the network frequency	45 to 55 if Fn = 50 Hz 55 to 65 if Fn = 60 Hz
VOLTAGE V _r 0 V 	Measure of the residual primary voltage	0 to 655 350V (NPIHD800 - NPIHD800R)
AVER. CURRENT I _o 0.0 A 	Value of the average earth-fault primary current	0 to 65535A
SETTING set 1 	Display of the active setting group	Set 1 or Set 2
E1E2E3E4E5E6E7E8 0 0 0 0 - - - - 	Display of the digital inputs (8 inputs for NPIHD)	0 if inactive or 1 if active
WD A B C D E F G 1 0 1 1 - - - - 	Display of the digital outputs (8 inputs for NPIHD)	0 if inactive or 1 if active
REL. HOLD RESET Confirm : ENTER 	ANSI 86*, reset of the latching function for the output relay	
24/01/11 10:19:42	Day / Month / Year Hour / minute / second	

* for ≥V2.20 see menu “Counters”

5.4 Overcurrent menu

This menu allows the setting of the phases and earth fault over current functions: setting in and out of order, choice of the types of time delay and curves, adjustment of thresholds, assignment of the output units.

This configuration must be carried out successively for each of the two settings groups if they are to be used alternatively.

MAIN MENU OVERCURRENT	Parameters of the ANSI 50N and 51N functions	
 		
SETTING set 1	Choose the setting group	Set 1 or Set 2
		
EARTH LOW I0> Active	Choose Active to use the earth low threshold of ANSI 51N function	Active or Inactive
<i>Or</i>		
EARTH I0> Active	Choose Active to use the earth low threshold ANSI 51N function	Active or Inactive (since V3)
		
DELAY TYPE tI0> Mod. Invers.ANSI	Select the type of time delay: definite; IEC : Inverse, Very inv, Ext. Inv, RI inv; ANSI : Mod Inverse, Very Inv. Ext. inv	
		
MOD. INV.ANSItI0> 0,25 s	Set the value of the time delay Definite : 0.04 to 300 s	RI Inverse : 0.1 to 20 s IEC and ANSI : 0.03 to 3 s
		
THRESHOLD I0> 1.20 * In	Set the threshold I0>.	0.03 to 2.40 * In
		
REL. INST. I0> A B C D	Select relay to assign to the instantaneous function	
		
REL. INST. I0> E F G		(D, E, F, G relays if option available)
		
REL. TRIP tI0> A B C D	Select relay to assign to the trip function	See chap 4 to choose a relay or to modify the assignment
		
REL. TRIP tI0> E F G		(D, E, F, G relays if option available)



EARTH HIGH Io>>
Active

Choose Active to use the earth high threshold of ANSI 50N function

Active or Inactive

Or

EARTH Io>>
Active

Choose Active to use the earth high threshold of ANSI 50N function

Active or Inactive (since V3)



DEFINITE tIo>>
0,60 s

Set the value of the time delay

0.04 to 300 s



THRESHOLD Io>>
1.20 * In

Set the value of the threshold Io>>

0.03 to 2.40 * I0n



REL. INST. Io>>
A B C D

Select relay to assign to the instantaneous function

See chap 4 to choose a relay or to modify the assignment



REL. INST. Io>>
E F G

(D, E, F, G relays if option available)



REL. TRIP tIo>>
A B C D

Select relay to assign to the trip function

See chap 4 to choose a relay or to modify the assignment









REL. TRIP tIo>>
E F G

(D, E, F, G relays if option available)









5.5 Directional menu (only NPIHD800 and NPIHD800R)

This menu allows the parameter setting of the earth-fault directional function: setting in and out of order, choice of angle and threshold of polarization.

MAIN MENU DIRECTIONAL	Parameters of the earth directional functions	
 		
SETTING set 1	Choose the active setting group	Set 1 or Set 2
		
EARTH LOW DIREC. Active	Choose Active to use the directional on the 51N threshold	Active or Inactive
Or		
EARTH DIREC. > Active	Choose Active to use the directional on the 51N threshold	Active or Inactive (since V3)
		
EARTH HIGH DIREC Active	Choose Active to use the directional on the 50N threshold	Active or Inactive
Or		
EARTH DIREC. >> Active	Choose Active to use the directional on the 50N threshold	Active or Inactive (since V3)
		
ANGLE EARTH DIR. 45 °	Adjustment of the directional angle of the earth 50N/51N	- 180° to + 180°
		
POLARISATION Vo 3 % Vn	Set the value of the threshold of polarization	3 % to 20 % * Vn
		
INHIB EARTH DIR. Inactive	Choose <i>Active</i> to inhibit the earth directional function when Vn < Vo	

5.6 Generic functions menu







This menu allows the parameter setting of 4 or 8 (according option or relay type) customized functions: setting in and out of order, adjustment of the time delays, assignment of the output units and assignment of a digital input.

MAIN MENU GENERIC FUNCTION	Parameters of the customized functions	
 		
FCT GENERIC 1 Disable	Choose <i>Trip</i> or <i>Report*</i> to use generic function 1	Trip or Report* or Disabled
		
TEMP GENERIC 1 0.06 s	Set the time delay of the generic function 1	0.04 to 300 s
		
REL. GENERIC 1 A B C D	Select relay to assign to generic function 1	
		
REL. GENERIC 1 E F G		(D, E, F, G relay if option available)
		
DIG. INP. GENER. 1 Input 1	Display of input selected for generic function 1	No input, Input 1 to 8 (or 1 to 4 according option)
		
Name GENERIC 1 GENERIC 1	Display of the wording of function 1	No input, Input 1 to 8 (or 1 to 4 according option)
		
.....		

* The **“Report”** mode is available since V2.20 version.







5.7 Closing function menu

This menu authorizes the parameter setting of the closing function: time delay of start, assignment of a digital input.

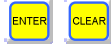
MAIN MENU CLOSING FUNCTION	Parameters of the closing function	
 		
CLOS. TIME MODE 0.06 s	Set the start time delay	0.04 to 300.00 s
		
CLOS. MODE RATIO 50 %	Set the start ratio	50 to 200 %
		
EARTH HIGH I0>> Inactive	Choose Active to modify the threshold during start	Active or Inactive
or		
EARTH I0>> Inactive	Choose Active to modify the threshold during start	Active or Inactive (since V3)
		
EARTH LOW I0> Inactive	Choose Active to modify the threshold during start	Active or Inactive
or		
EARTH I0> Inactive	Choose Active to modify the threshold during start	Active or Inactive (since V3)
		
CLOS. MODE INPUT No input	Display of the selected digital input	No input, Input 1 to 8 (or 1 to 4 according option)

5.8 Logical selectivity menu

This menu authorizes the parameter setting of the logical selectivity function: setting in and out of order, adjustment of the time delays, operating mode.











MAIN MENU LOG. SELECTIVITY 	Parameters of the logical selectivity option	
SETTING set 1 	Choose the active setting group	Set 1 or Set 2
EARTH LOW S.LOG. Active or	Choose Active to use the earth low threshold	Active or Inactive
EARTH Io> S.LOG. Active 	Choose Active to use the earth low threshold	Active or Inactive (since V3)
EARTH LOW S.LOG. 0,06 s or	Set the additional time delay of the earth low threshold function	0.06 to 120 s
EARTH Io> S.LOG. 0,06 s 	Set the additional time delay of the earth low threshold function	0.06 to 120 s
EARTH HIGH S.LOG Active or	Choose Active to use the earth high threshold	Active or Inactive
EARTH Io> S.LOG Active 	Choose Active to use the earth high threshold	Active or Inactive (since V3)
EARTH HIGH S.LOG 0,17 s or	Set the additional time delay of the earth high threshold function	0.06 to 3.0 s
EARTH Io> S.LOG 0,17 s 	Set the additional time delay of the earth high threshold function	0.06 to 3.0 s
CLOS. MODE INPUT No input	Display of the digital input selected for the function.	No input, Input 1 to 8 (or 1 to 4 according option)



5.9 Telecontrol menu

This menu allows enabling the remote control functions, choice of the level of load-shedding, choice of the reclose time delay assignment of the trip and reclose relays and choice of the reclose pulse.













This menu is available if the communication option is available.

5.9.1 Telecontrol menu (V1.24 and V2.xx Firmware)

MAIN MENU TELECONTROL	Information about remote control option	
		
TELECONTROL Active	Choose Active to use remote control option	Active or Inactive (Active if communication available)
		
LOAD SHED LEVEL 6	Set the level of load-shedding.	1 to 6 (Level 6 inhibits the load-shedding function)
		
RE-LOAD DELAY 20.00 s	Set the time delay before reclosing	1.00 s to 120.00 s
		
TRIP RELAY A B C D	Select relay to assign to remote control trip	See chap 4 to choose a relay or to modify the assignment
		
TRIP RELAY E F G		(D, E, F, G relay if option available)
		
RECLOSE RELAY A B C D	Select relay to assign to remote control close order	See chap 4 to choose a relay or to modify the assignment
		
RECLOSE RELAY E F G		(D, E, F, G relay if option available)
		
RECLOSE PULSE 200 ms	Setting of the minimum duration of reclosing pulse	100 to 500 ms
		
O/O INPUT Input 1	Display of input assigned to the O/O interlock position (CB closed)	No input, Input 1 to 8 (or 1 to 4 according option)
		

C/O INPUT Input 2	Display of input assigned to the F/O interlock position (CB open)	No input, Input 1 to 8 (or 1 to 4 according option)
		
LOCAL INPUT Input 3	Display of input assigned to the LOCAL operation mode	No input, Input 1 to 8 (or 1 to 4 according option)
		
DISTANT INPUT Input 4	Display of input assigned to the REMOTE operation mode	No input, Input 1 to 8 (or 1 to 4 according option)





5.9.2 Telecontrol menu (since V3.00 Firmware)

MAIN MENU TELECONTROL	Information about remote control option	
 		
TELECONTROL Active	Choose Active to use remote control option (Available if the communication option is present)	Active or Inactive
		
LOAD SHED LEVEL 2	Set the level of load-shedding. Level 6 inhibits the load-shedding function (Available if the communication option is present)	1 to 6
		
RE-LOAD DELAY 20.00 s	Set the time delay before reclosing (Available if the communication option is present)	1.00 s to 120.00 s
		
TRIP RELAY A B C D	Select relay to assign to remote control trip order	See chap 4 to choose a relay or to modify the assignment
		
TRIP RELAY E F G		(D, E, F, G relay if option available)
		
RECLOSE RELAY A B C D	Select relay to assign to remote control close order	See chap 4 to choose a relay or to modify the assignment
		
RECLOSE RELAY E F G		(D, E, F, G relay if option available)
		
RECLOSE PULSE 200 ms	Setting of the minimum duration of reclosing pulse	100 to 500 ms
		
O/O INPUT Input 1	Display of input assigned to the O/O interlock position (CB closed)	No input, Input 1 to 8 (or 1 to 4 according option)
		
C/O Input Input 2	Display of input assigned to the C/O interlock position (CB open)	No input, Input 1 to 8 (or 1 to 4 according option)
		

LOCAL INPUT No input	Display of input assigned to the LOCAL operation mode (Available if the communication option is present and if the management of input(s) number Local/distant is carried out with 2 digital inputs)	No input, Input 1 to 8 (or 1 to 4 according option)
		
DISTANT INPUT Input 4	Display of input assigned to the REMOTE operation mode (Available if the communication option is present)	No input, Input 1 to 8 (or 1 to 4 according option)







5.10 Disturbance recording menu

This menu is used to configure the parameters of the disturbance recording.

MAIN MENU PERTURBOGRAPHY	Information about disturbance recording	
 		
PRE-TIME 35 period(s)	Set pre time of disturbance recording Ex : 35 periods = 700 ms (50Hz)	0 to 52
		
PERTURBO. INPUT E5	Display of input assigned to the external disturbance recording triggering	No input, Input 1 to 8 (or 1 to 4 according option)
		
REL. DISTURB. A B C D	Select relay to assign to disturbance recording trip (Available from V3.00 Firmware)	See chap 4 to choose a relay or to modify the assignment
		
REL. DISTURB. E F G		(relays D, E, F, G if option available)

5.11 Counters menu

This menu allows the parameter setting of the counters: display of cut A^2 , number of circuit breaker operations, energies, current maximeters, max of powers, reset of the counters.









MAIN MENU COUNTERS	Information about the different counters	
 		
NBER OPERATIONS 100	Display of the number of operations of the circuit breaker	Following a trip and clear of the fault
		
RESET NB OPERAT. Confirm : ENTER	Reset of the number of operations of the circuit breaker	
		
REL. HOLD RESET Confirmer: ENTER	ANSI 86*, reset of the latching function for the output relay	
		
MAX.METER I0 10 A	Display of the earth current maximeter	
		
MAX.METER RESET Confirm : ENTER	Reset of the current maximeter	

*The "REL.HOLD.RESET" function is available since V2.20 Firmware. (For V3.00, see the "Maintenance" menu).

5.12 Operation menu

This menu authorizes the parameter setting of the operation function: choice of the language, adjustment of LCD contrast, parameter setting of the values of the earth-fault CTs, parameter setting of the rated primary and secondary voltage of the VTs, display of the digital input corresponding to set 2, trip pulse, maximum of cut A² and number of operations of the circuit breaker, assignment of the relays for circuit breaker failure and discrepancy, average current and power.

5.12.1 Operation menu (Firmware V1.24 and V2.XX)

MAIN MENU OPERATION	Operating parameters to be defined at commissioning	
		
LANGUAGE English	Choice of the language used locally by protection	French, English, Italian or Spanish
		
ADJUST LCD 200	Adjustment of the angle of vision of the LCD display	70 to 255
		
I _o NOMINAL PRIM. 20 A	Set the value of the earth primary rated current of the CT or CBCT	1 to 10 000 A
		
U NOMINAL PRIM. 1000 V	Value of the phase to phase rated primary voltage of phase VTs	220 V to 250 000 V
		
U NOMINAL SECOND 100,0 V	Value of the phase to phase rated secondary voltage of phase VTs	33 to 120 V
		
INPUT SET 2 E6	Display of input assigned to setting group 2	No input, Input 1 to 8 (or 1 to 4 according option)
		
CLEAR REL. INPUT E5	Display of input assigned to reset of relays.	No input, Input 1 to 8 (or 1 to 4 according option)
		
TRIP PULSE 100 ms	Setting of minimum duration of trip pulse	100 to 500 ms
		
MAX NBER OPERAT. 2000	Adjustment of the maximum number of operations of the circuit breaker	1 to 10 000



RELAY C.B. FAULT
A B C D

Select the relay assigned to the circuit breaker failure function

See chap 4 to choose a relay or to modify the assignment



RELAY C.B. FAULT
E F G

(D, E, F, G relay if option available)



RELAY DISC. L/D
A B C D

Select the relay assigned to the local/distant discrepancy function

See chap 4 to choose a relay or to modify the assignment



RELAY DISC. L/D
E F G

(D, E, F, G relay if option available)



























NB OF INPUTS L/D
1 input

Number of input(s), configurable for the management of the Local/Distant mode

1 or 2 DI,

5.12.2 Operation menu (since V3)

MAIN MENU OPERATION	Operating parameters to be defined at commissioning	
 		
LANGUAGE FRENCH	Choice of the language used locally by protection	French, English, Italian or Spanish
		
ADJUST LCD 200	Adjustment of the angle of vision of the LCD display	70 to 255
		
I _o NOMINAL PRIM. 20 A	Set the value of the earth primary rated current of the CT or CBCT	1 to 10 000 A
		
CONNECTION I _o WITHOUT BA800	Choose the type of connection according to cbct Connection on cbct only	without BA800 (100 turns) or with BA800 (1500 turns)
		
U NOMINAL PRIM 20000 V	Value of the phase to phase rated primary voltage of phase VTs	220 to 250 000 V (NPIHD800 and NPIHD800R)
		
U NOMINAL SECOND 100,0 V	Value of the phase to phase rated secondary voltage of phase VTs	33 to 120 V (NPIHD800 and NPIHD800R)
		
SET 2 INPUT E6	Display of input assigned to setting group 2	No input, Input 1 to 8 (or 1 to 4 according option)
		
CLEAR REL. INPUT E5	Display of input assigned to reset of relays	No input, Input 1 to 8 (or 1 to 4 according option)
		
TRIP PULSE 200 ms	Setting of minimum duration of trip pulse	100 to 500 ms
		
MAX NBER OPERAT. 2000	Adjustment of the maximum number of operations of the CB	1 to 10 000
		
RELAY C.B. FAULT A_ B C D	Select the relay assigned to the circuit breaker failure function	(remote control in service)

 RELAY C.B. FAULT E_ F G		(D, E, F, G relay if option available)
 REL.L/R NO-COMPL A_ B C D	Relay assigned to function of no-complementarity local/distant	(remote control in service)
 REL.L/R NO-COMPL E_ F G		(D, E, F, G relay if option available)
 NB OF INPUTS L/R 2 inputs	Configurable for the management of the Local/Remote mode	1 or 2 digital inputs
 CONTROL CB POSIT Inactive	Choose Active to use the management of the CB position	Active or Inactive
 CLOS. LOC. INPUT No input	Display of input assigned to the closing in local (configurable with PC software)	Active or Inactive
 TRIP.LOC.INPUT No input	Display of input assigned to the tripping in local (configurable with PC software)	Active or Inactive
 UVR REL. ASSIGN. C D G	Select the relay(s) to be assigned in CB under voltage release trip circuit (D and G if option available)	
 RELAY A OUTPUT A	Display the label of the output unit A	(configurable with the PC software)
 RELAY B OUTPUT B	Display the label of the output unit B	(configurable with the PC software)
 RELAY C OUTPUT C	Display the label of the output unit C	(configurable with the PC software)
 RELAY D OUTPUT D	Display the label of the output unit D (if option available)	(configurable with the PC software)



RELAY E
OUTPUT E

Display the label of the output unit E
(if option available)

(configurable with the PC
software)



RELAY F
OUTPUT F

Display the label of the output unit F
(if option available)

(configurable with the PC
software)









RELAY G
OUTPUT G

Display the label of the output unit G
(if option available)

(configurable with the PC
software)

5.13 Modbus® Communication menu (optional)

This menu is used to set the parameters of the Modbus® communication function: slave number, size, speed, activity and loop tests.

MAIN MENU COMMUNIC. MODBUS	Configuration of the Modbus RS485 communication option	V1.24 and V2.xx Firmware
Or		
MAIN MENU RS485 COMMS	Configuration of the Modbus RS485 communication option	Since V3.00 Firmware
 		
SLAVE NUMBER 2	Slave number of protection	1 to 255
		
FORMAT 8b+0p+ASCII2s	number of bits + parity + bits of stop + ASCII/Binary format	Parity: 1p = pair, 1i = odd, 0p= without p0 = forced to 0, p1 = forced to 1
		
SPEED 9600 bauds	Speed transmission on RS485 link	300, 600 ,1200 ,1800, 2400, 4800, 9600, 19200 38400, 57 600,115 200 bauds
		
RECEPT. TIMEOUT 0.10 s	Set the time delay of reception timeout	0.10 to 20 s
		
ACTIVITY TIMEOUT 0.20 s	Set the time delay of activity timeout	0.10 to 20 s
		
ACTIVITY TEST Mes.Not Received	Test of the parameter setting and the wiring of Modbus	message received / not received: correct activity / communication problem





5.14 Change of code menu

This menu allows change of code and is described in chapter Access Code.







5.15 Information menu

Information menu specifies the factory set characteristics of the protection, as well as the wording assigned by the User.

5.15.1 Information menu (V1.24 and V2.xx firmware)

MAIN MENU INFORMATION	Information about protection	
 		
NP.IHD.800 50 Hz	Type of protection Rated frequency	NPIH800 or NPIHD800 50 Hz or 60 Hz
		
PROC. VER. x.xx	Version of the software of protection	
		
EARTH RAT. 0.2 A	Display of the earth rating	
		
NP 800 ICE	32 characters zone programmable with the setting software.	

5.15.2 Information menu (since V3.00)



MAIN MENU INFORMATION	Information about protection	
 		
NPI800 50 Hz	Type of protection Rated frequency	NPIH800 or NPIHD800 50 Hz or 60 Hz
		
PROC. VER. 3.xx	Version of the protection software	
		
EARTH RAT. 5A	Display of the earth rating	
		
V _r MEASURED	Calculation method of the residual voltage V _r	NPIHD only
		
NP 800 ICE	32 characters zone programmable with the setting software	
		
SERIAL NUMBER xx.xxxxxxxxxxxxxx	Serial number of the protection	

6.2 Customized inputs events

Events are recorded as soon as one of the customized input status changes.

◆ TRIP GENERIC

Detail of available information can be consulted for each event, in accordance with the list below:



TRIP GENERIC S 25/03 11:45:07 R	Type of fault Start or End of fault Day/Month Hour/Minute/Second - Dated event Relative/Synchronous
 25/03/03 11:45:07.310	Day / Month / Year Hour: Minute: Second. Millisecond
 SETTING set 1	Active setting group Set 1 or Set 2

6.3 Other events

The contents of the following events can be specified:

- ◆ TRIP TELECONTR
- ◆ RECLOSE TELECO
- ◆ DISC LOCA/REMO
- ◆ CB FAIL
- ◆ ALRM NB OPERAS
- ◆ MODE REMOTE
- ◆ UNLISTED EVENT
- ◆ ALRM COIL
- ◆ ALRM CDE BREAK

Detail of available information can be consulted for each event, in accordance with the list below:

DISC LOCA/DIST S 17/03 14:47:31 R	Type of fault Start or End of fault Day/Month Hour/Minute/Second - Dated event Relative/Synchronous
 17/03/03 17 :47 :31.010	Day / Month / Year Hour: Minute: Second. Millisecond
 SETTING set 1	Active setting group Set 1 or Set 2

6.4 Acknowledgement of events

The acknowledgement of the last event is carried out while pressing on CLEAR key:

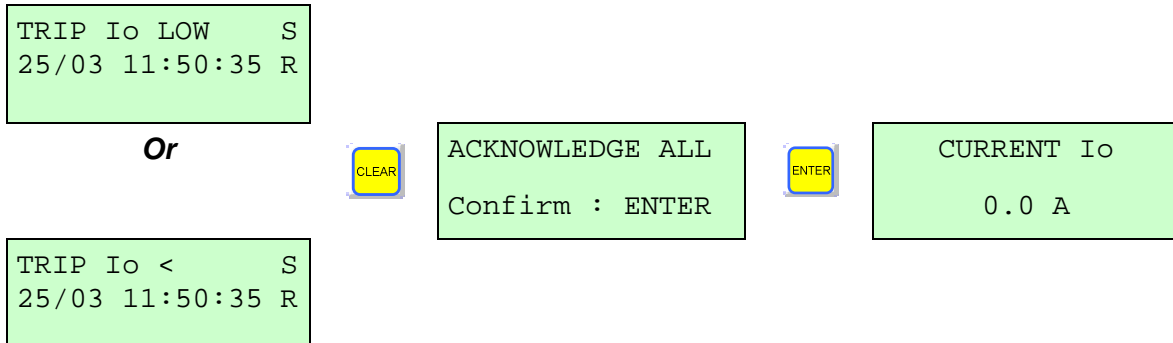

6.5 Reading of the last 250 memorized events

After acknowledgement, the memorized events still may be read. It is necessary to use the local sub-menu EVENTS of the MMI.

7. List of faults or operation messages

7.1 List of faults or operation messages (Firmware V1.24 and V2.xx)

The following messages are locally displayed in real time on LCD display throughout fault.

Messages related to instantaneous type functions:

INSTANT. EARTH HIGH THRESHOLD
INSTANT. EARTH LOW THRESHOLD

Messages related to trip type functions:

TRIP EARTH HIGH THRESHOLD
TRIP EARTH LOW THRESHOLD
TRIP BY TELECONTROL
TRIP GENERIC FUNCTION

Messages related to alarm type functions:

DISCORDANCE : LOCAL / REMOTE
CIRCUIT BREAKER FAIL
ALARM NUMBER OPERATIONS
ALARM COIL CIRCUIT BREAKER
ALARM CURRENT CIRCUIT BREAKER

Various messages:

RECLOSE BY TELECONTROL
REMOTE MODE
UNLISTED EVENT

Notes: Disappearance of number of operations alarm is done by resetting the COUNTERS menu. To cause the disappearance of the last fault or operation message, it is possible to press on CLEAR key of the keyboard.

7.2 List of faults or operation messages (since firmware V3.00)

The following messages are locally displayed in real time on LCD display throughout fault.

Messages related to instantaneous type functions:

INSTANT. lo >>

INSTANT. lo >

Messages related to trip type functions:

TRIP lo >>

TRIP lo >

TRIP BY TELECONTROL

TRIP GENERIC FUNCTION

Messages related to alarm type functions:

ALARM NUMBER OPERATIONS

CIRCUIT BREAKER FAIL

NO-COMPL. L/R

ALARM COIL CIRCUIT BREAKER

ALARM CURRENT CIRCUIT BREAKER

Various messages:

RECLOSE BY TELECONTROL

LOSS AUX.SUPP.

RET. AUX.SUPP.

REMOTE MODE

UNLISTED EVENT

Notes: Disappearance of number of operations alarms is done by resetting the COUNTERS menu. To cause the disappearance of the last fault or operation message, it is possible to press on CLEAR key of the keyboard.

8. Connection of NPIH800 and NPIHD800 protections

8.1 Rear view of NPIH800 and NPIHD800 with location of the terminal blocks (with short-circuiting devices)

Extension board (connectors E, F, G and RS485-2) is optional on the NPIH800 and NPIHD800 and connector A is not used on the NPIH800.

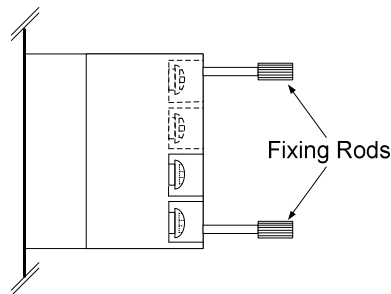
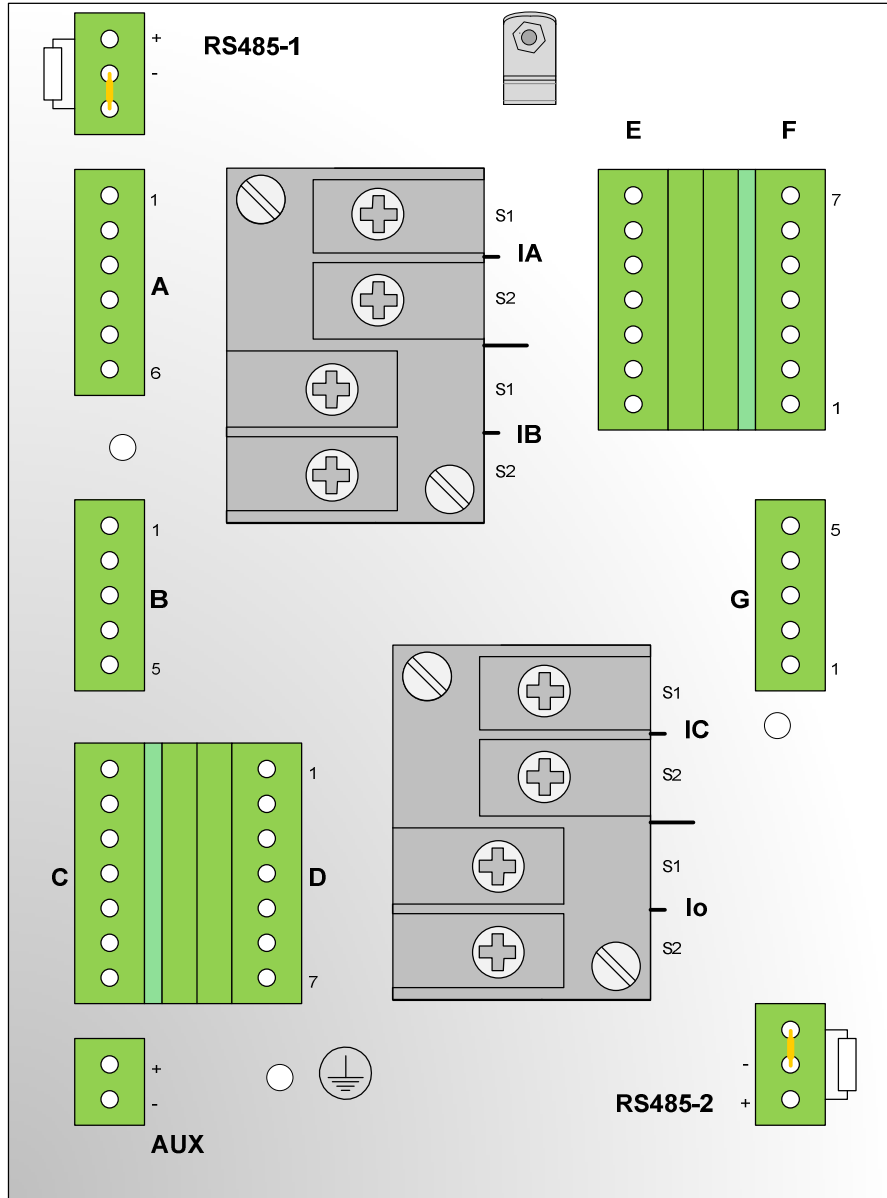

Side view of the current terminal block with short-circuiting devices

8.2 Rear view of NPIH800 and NPIHD800 with location of the terminal blocks (without short-circuiting devices)

Extension board (connectors E, F, G and RS485-2) is optional on the NPIH800 and NPIHD800 and connector A is not used on the NPIH800.

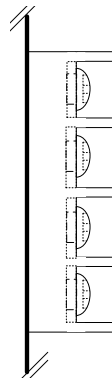
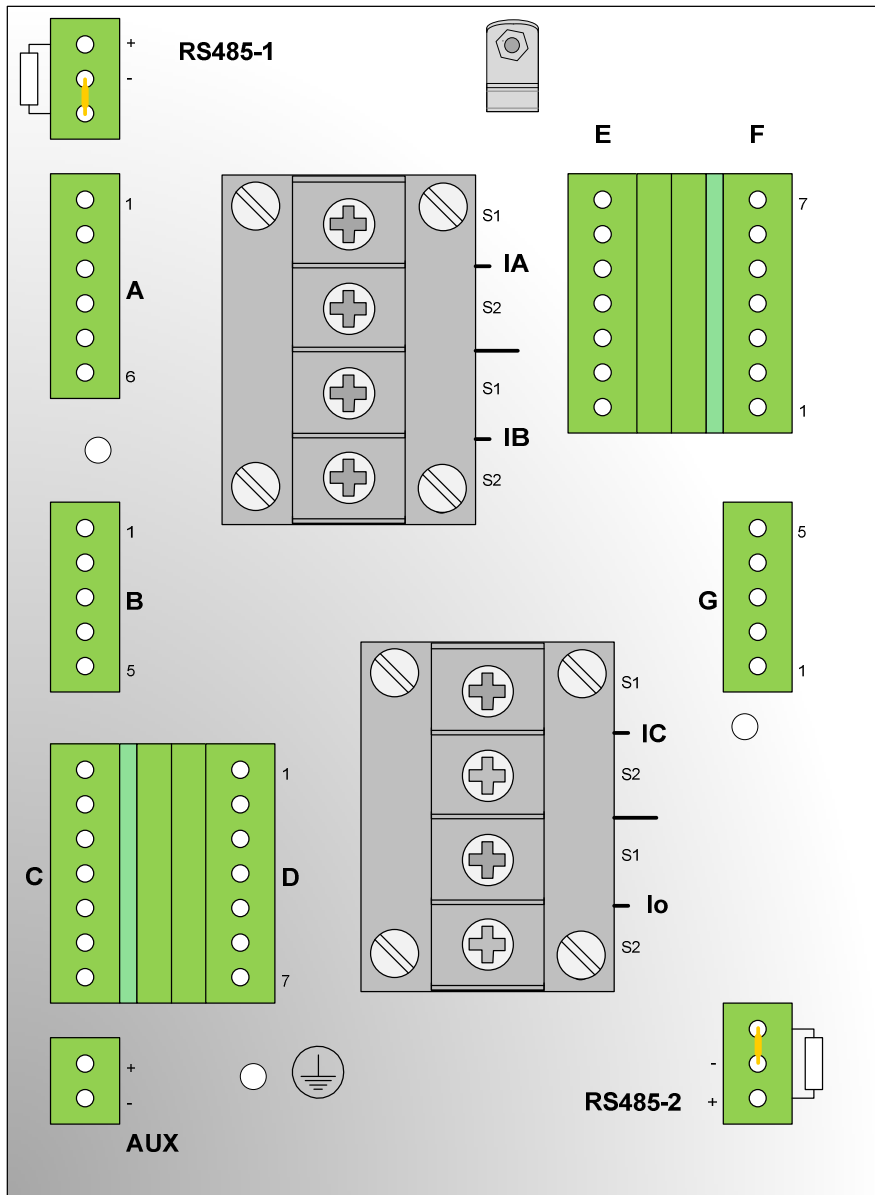

Side view of the current terminal block without short-circuiting devices

8.3 NPIH800 and NPIHD800 connections

Connections	Location	Characteristics
Modbus® or IEC870-5-103 Communication	RS485-1 RS485-2	Screw terminal block. Section of wire 0.6 to 2.5 mm ²
	A	Screw terminal block not used (NPIH800)
Connection of the VTs	A	Screw terminal block. Section of wire 0.6 to 2.5 mm ²
Digital inputs	B	Screw terminal block. Section of wire 0.6 to 2.5 mm ²
Relays	C and D	Screw terminal block. Section of wire 0.6 to 2.5 mm ²
Auxiliary supply	AUX	Screw terminal block. Section of wire 0.6 to 2.5 mm ²
Relays (optional board)	E and F	Screw terminal block. Section of wire 0.6 to 2.5 mm ²
Digital inputs (optional board)	G	Screw terminal block. Section of wire 0.6 to 2.5 mm ²
Connection of the CT	IO	4 mm ring type terminal. Section of wire ≤ 6 mm ²

8.4 NPIH800 and NPIHD800 diagrams

Type of relay	Observation	Reference of diagram
NPIH800		S 38021
NPIHD800		S 38022

9. Connection of NPIH800R and NPIHD800R relays

9.1 Rear view of NPIH800R with location of the terminal blocks

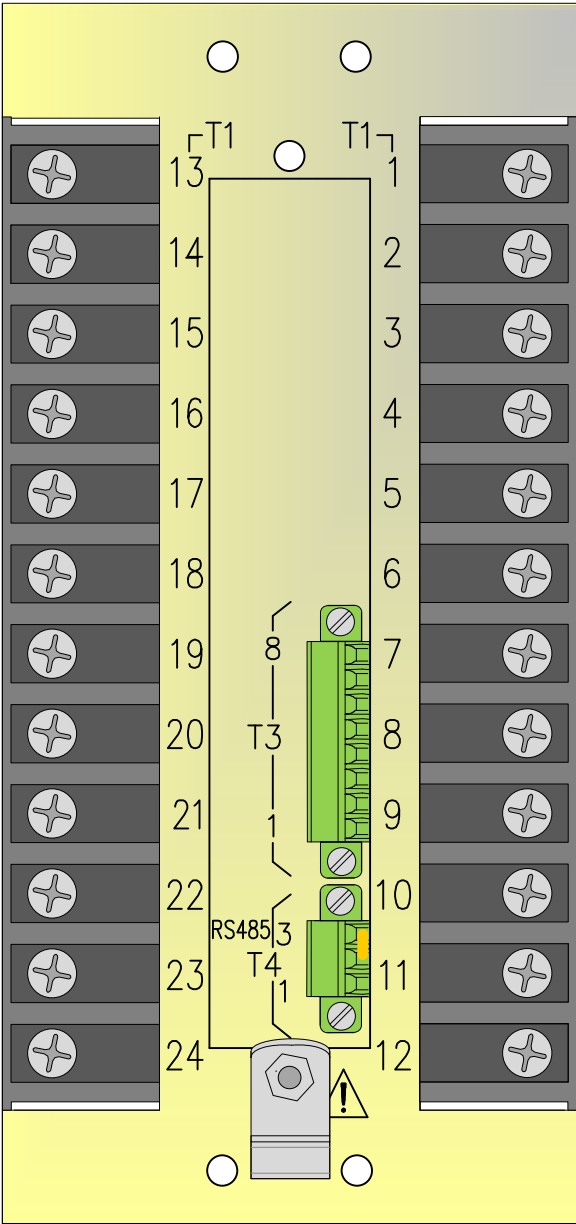

Case R2

This document is the sole property of ICE. No duplication nor release to third party is allowed without prior authorization

User's Guide NPIH800 – NPIHD800 NPIH800R – NPIHD800R	Date : 01/2011 Print : 04/05/2011	Folio : 44 Indice : e

9.2 Rear view of NPIHD800R with location of the terminal blocks

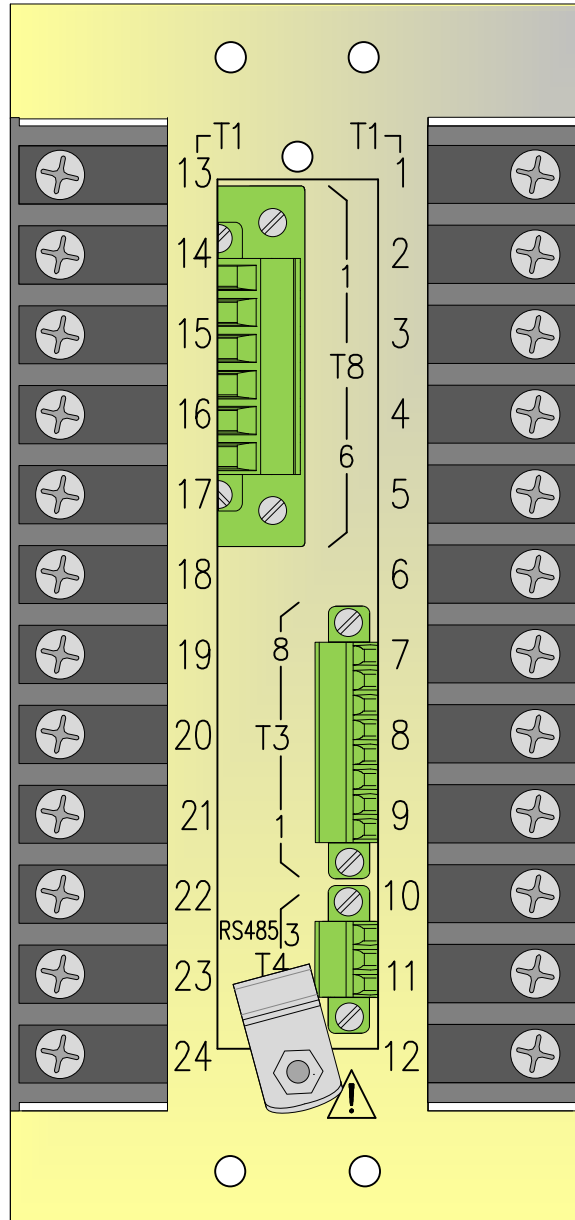

Case R2

9.3 NPIH800R – NPIHD800R Fixing rods

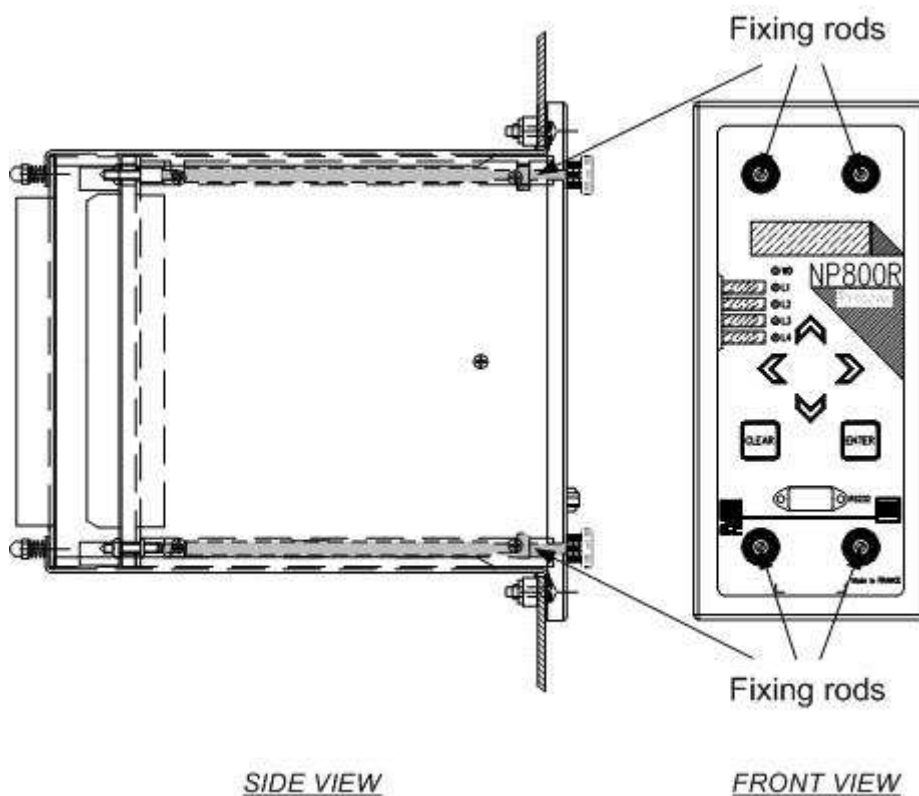

9.4 NPIH800R connections

NPIH800R (Case R2)		
Connections	Terminal Blocks	Location
Auxiliary supply	T1	4-5
Connection of the CTs		14-15,
Relay A		16-17, 18-19
Relay B		20-21, 22-23
Relay C		8-9, 8-12
Relay WD		13-24
Digital inputs 1 to 4	T3	1-2, 3-4, 5-6, 7-8
Modbus® or IEC870-5-103 Communication (RS485)	T4	1 to 3

For CTs inputs, take care to follow the rotating sense of phases and the direction of the connection of each phase during the wiring.

9.5 NPIHD800R connections

NPIHD800R (Case R2)		
Connections	Terminal Blocks	Location
Auxiliary supply	T1	4-5
Connection of the CTs		14-15,
Relay A		16-17, 18-19
Relay B		20-21, 22-23
Relay C		8-9, 8-12
Relay WD		13-24
Digital inputs 1 to 4	T3	1-2, 3-4, 5-6, 7-8
Connection of the VTs	T8	1 to 6
Modbus® or IEC870-5-103 Communication (RS485)	T4	1 to 3

For CTs inputs, take care to follow the rotating sense of phases and the direction of the connection of each phase during the wiring.

9.6 NPIH800R and NPIHD800R wire section

Terminal Blocks	Characteristics
T1	4 mm ring type terminal. Section of wire $\leq 6 \text{ mm}^2$
T3	Screw terminal block. Section of wire 0.08 to 1.5 mm^2
T4	Screw terminal block. Section of wire 0.08 to 1.5 mm^2
T8	Screw terminal block. Section of wire 0.2 to 2.5 mm^2

9.7 NPIH800R and NPIHD800R diagrams

Type of relay	Observation	Reference of diagram
NPIH800R		S 39964
NPIHD800R		S 39965

10. Connection of the Modbus RS485 communication

10.1 Characteristics of the network cable

Recommended characteristics for the cable:

- Shielded twisted pairs, maximum length 1000 m.
- resistance < 100 ohms/km
- capacity between wires < 60 pF/m
- capacity between wire and shield < 100 pF/m

The NP800 and NP800R relays are fitted with one fixing clamp to hold the network cable and recover the shielding of the network cable:

- The network cable must be stripped
- The shielding braid of the cable must be in contact with the clamp

In order to ensure continuity of the cable and its earthing, check that the fixing clamp is tightened on the shield recovering the jacket.

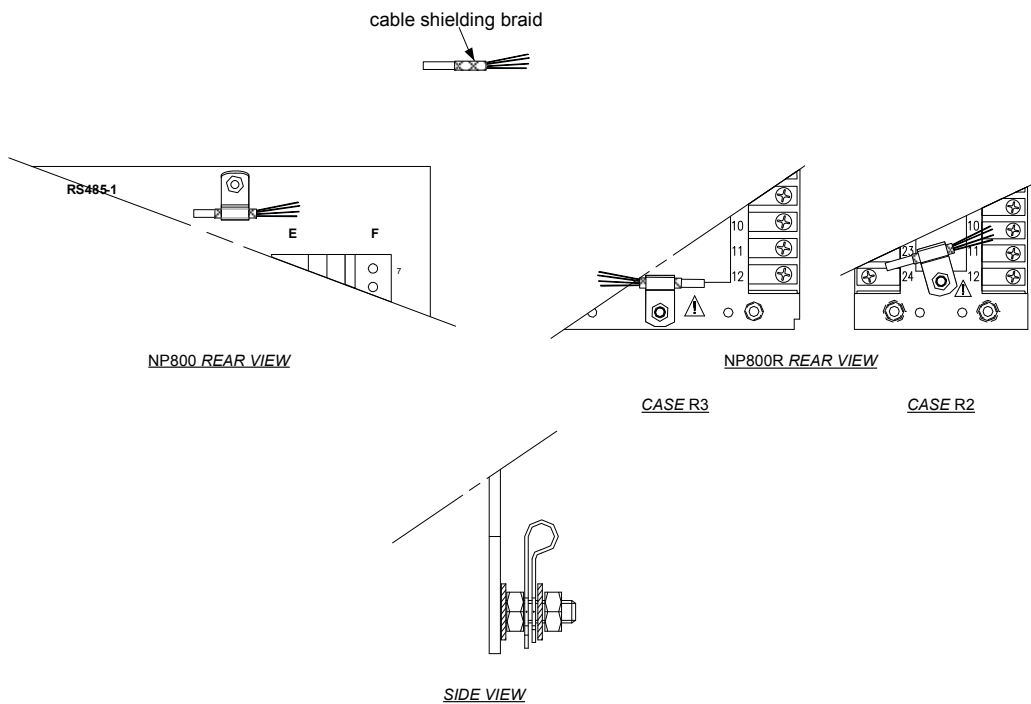

10.2 Resistance of adaptation of the RS 485 connection

In order to adapt the impedance of the RS 485 connection, two resistances of 120 ohms are necessary. With this intention, NP800 relays are fitted with a resistance of 120 ohms and a jumper provided for this purpose. To carry out this adaptation, according to the diagram below, connect the terminal "Rterm" to the terminal "- T/R" of the two end relays of the connection thanks to the jumper. The jumpers of the other relays of the connection will have to be removed

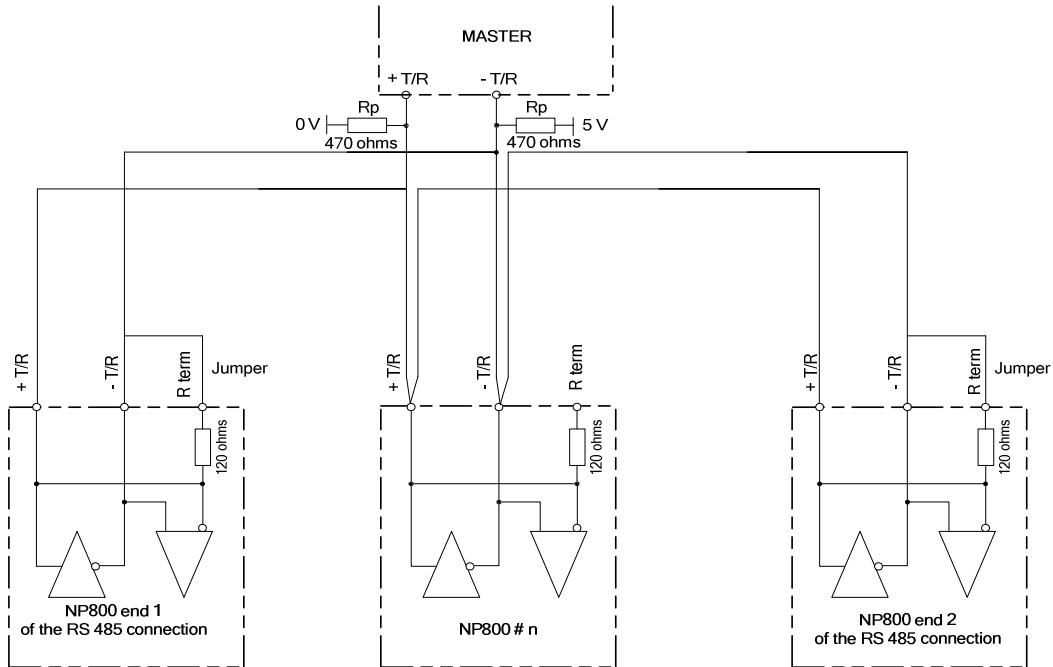

If the Master is connected at one end of the network, it is necessary to install a resistance of adaptation, not provided by ICE, then, according to the diagram below, connect the terminal "Rterm" to the terminal "- T/R" of the end relay of the connection thanks to the jumper. The jumpers of the other relays of the connection will have to be removed.

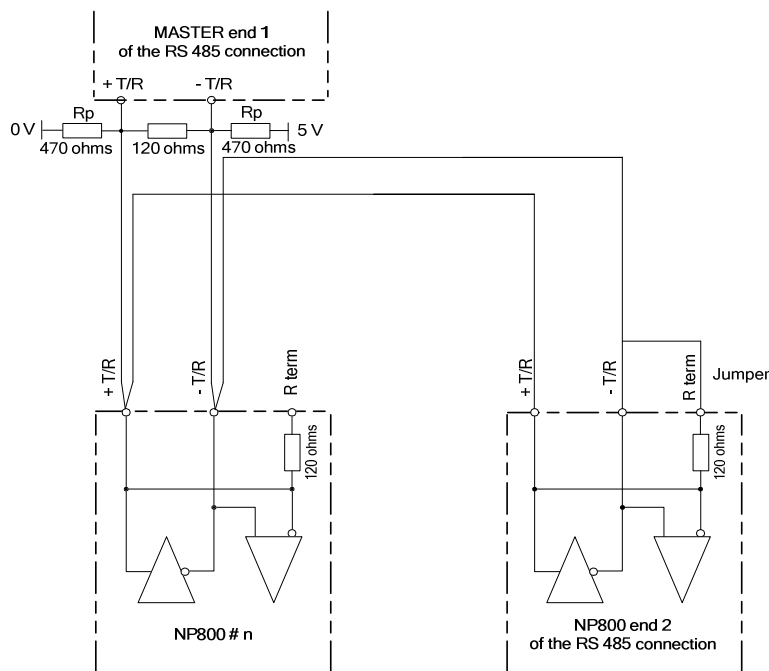

10.3 Polarization of the RS 485 connection

Polarization having to be single on a line to prevent the risks of transmission, it is in this case recommended to use the supplies and resistances (470 ohms) of polarization of the Master.

10.4 RS 485 connection not used

If the communication is not used, it is necessary to connect the terminal "Rterm" to the terminal "- T/R" of the relay thanks to the jumper(s) fitted for this purpose (RS485-1 and RS485-2).

